

ASSEMBLY INSTRUCTION

MODEL: 5998C





Read this instruction carefully, remove all wrapping material, staples and straps from the carton. See hardware and furniture part list

For guidance. Be sure you have all wooden furniture parts on a clean and soft surface to prevent from being scratched. Follow the figure to start assembling.

Caution:

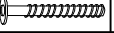
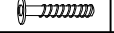
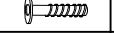
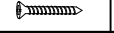
1. Do not FULLY -TIGHTEN the nut or bolt until all nut or nut bolt is ready to assembled.
2. Do not OVER- TIGHTEN the nut or nut bolt to avoid causing damages to the thread.
3. Keep all hardware part out of reach of children.

NO	PART LIST	QTY
A	BACK REST	1
B	FRONT LEG	2
C	BOX SEAT	1
D	CUSHION SEAT	1

NO	DESCRIPTION	QTY
1	JCBC SCREW M6 X 80MM 	4
2	JCBC SCREW M6 X 60MM 	4
3	JCBC SCREW M6 X 40MM 	2
4	CSK SCREW M4 X 30MM 	3
5	SPRING WASHER 	10
6	FLAT WASHER 	10
7	M4 ALLEN KEY 	1

STEP 1

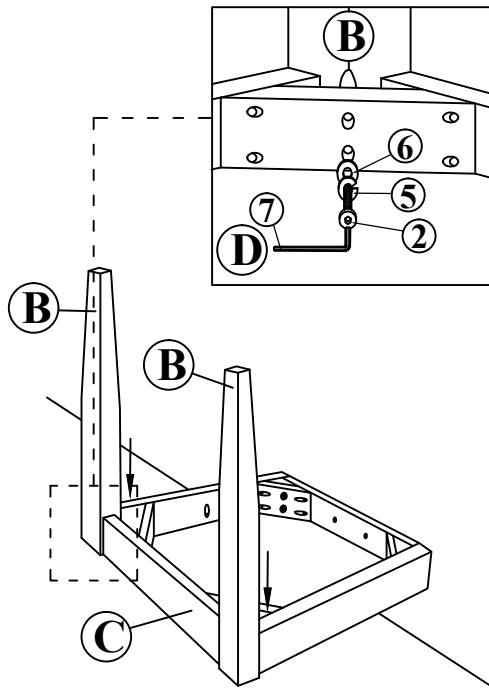

STEP 2

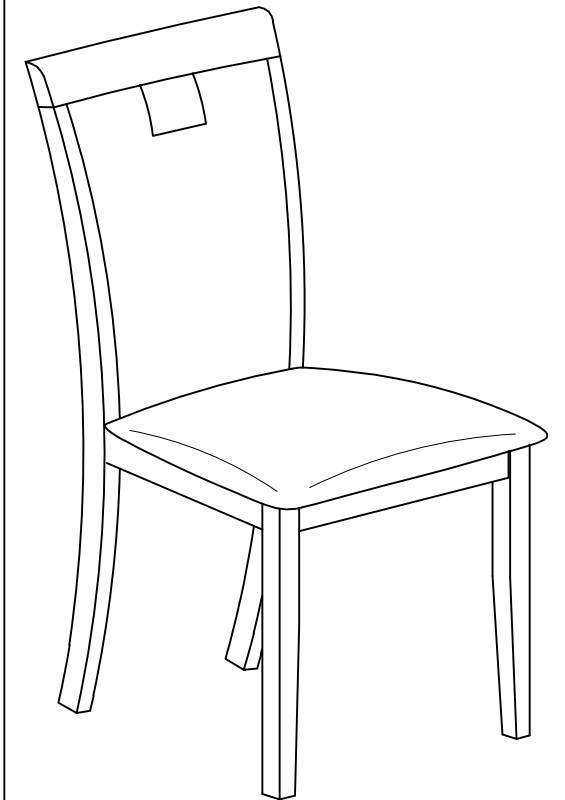
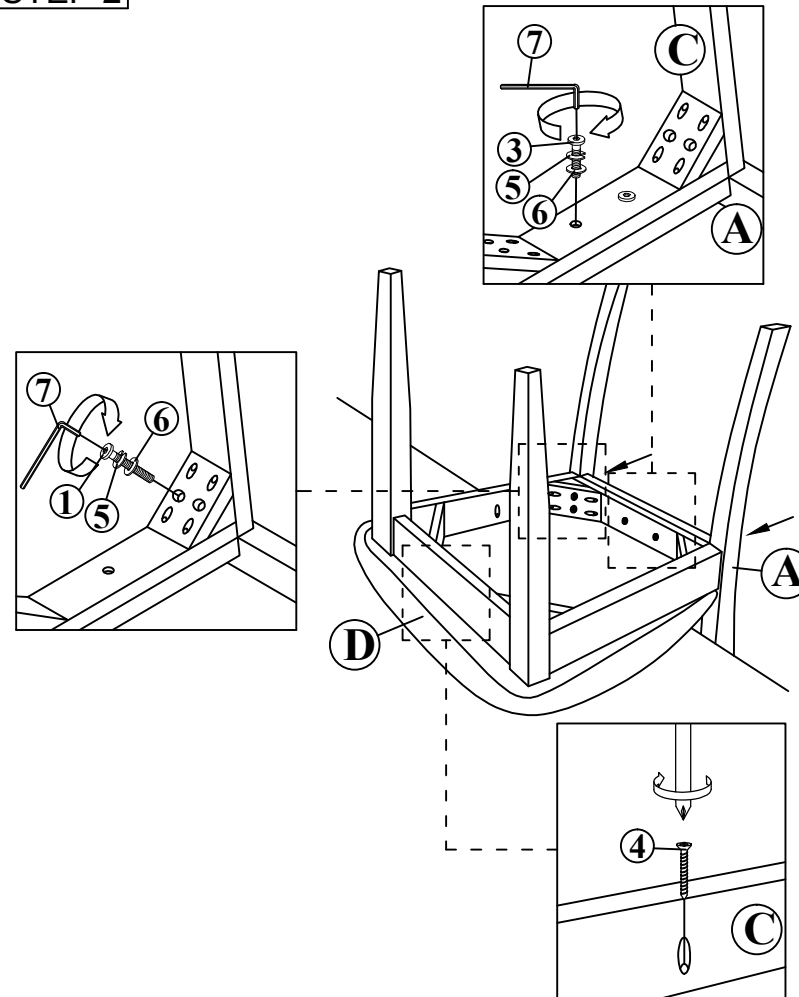

COMPLETED ASSEMBLY

ASSEMBLY INSTRUCTION

MODEL : 7230T





Read this instruction carefully. Remove all wrapping material, staples and straps from the carton. See hardware and furniture part list

For guidance. Be sure you have all wooden furniture parts on a clean and flat soft surface, such as a carpet or rug, to prevent from being scratched. Follow the figure to start assembling.

CAUTION :

1. Do not FULLY - TIGHTEN the nut or screw untill all is ready to assemble.
2. Do not OVER - TIGHTEN the nut or screw to avoid causing damages to the thread.
3. Keep all hardware part out reach of children.

NO	PART LIST	QTY
A	TABLE TOP	1 PC
B	TABLE LEG	4 PCS

NO	DESRPTION		QTY
1	JCBC SCREW M6 x 70MM		8 PCS
2	FLAT WASHER 6/19"		8 PCS
3	SPRING WASHER 6/13"		8 PCS
4	M4 ALLEN KEY		1 PC

